

EXEN
by
bürotime

document technique



EXEN



“Les approches pédagogiques évoluent avec les technologies en développement constant. Ces changements créent des opportunités pour de nouvelles méthodes d’enseignement et accélèrent les modulations vers des environnements actifs d’enseignement, focalisés sur les élèves/étudiants. Les designs Bürotime ne limitent pas l’enseignement aux zones considérées comme classiques et prédéfinies. Au contraire, ils construisent de nouvelles approches de pédagogie active. Bürotime propose des solutions efficaces qui transformeront petit à petit chaque parcelle d’un établissement d’enseignement en lieu d’apprentissage.”



La ligne caractéristique d'Exen maximise le succès des salles de classe de nouvelle génération, façonnées par les approches de pédagogie active. La conception élégante de ses pieds — permettant un réglage en hauteur — allie durabilité et fonctionnalité.

Le rangement à livres et le porte-sac situés sous la table permettent de respecter l'environnement d'apprentissage en apportant de l'ordre dans les salles de travail.



famille de produits _____



rang simple



rang double

caractéristiques de la table _____

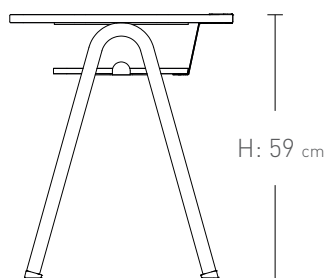
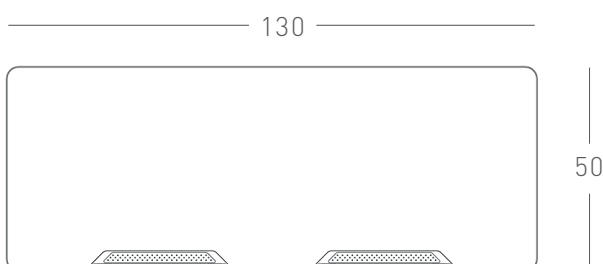
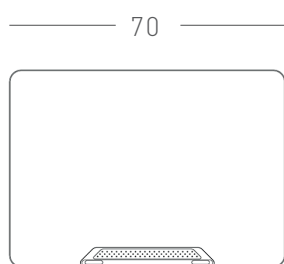

petit
6-8 ans

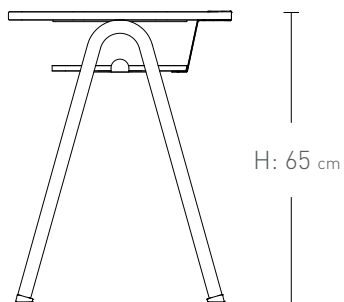

moyen
8-11 ans

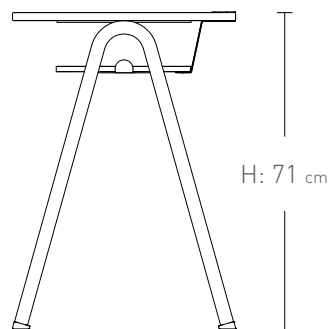

grand
11-14 ans



options de couleur de la table _____ mélamine

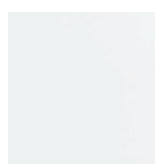

blanc

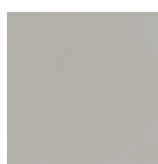

sable

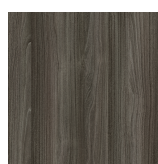

chêne fumé

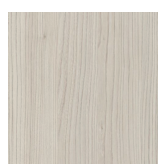

chalef

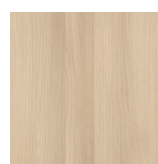

acacia

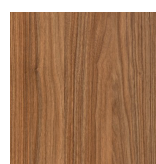

noyer samba

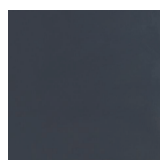

anthracite

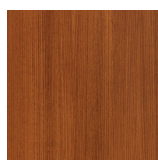

noisette



gris



chêne naturel

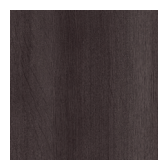

chêne africain

métal

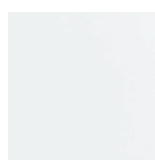

blanc



gris

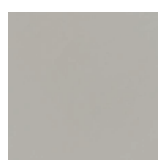

sable

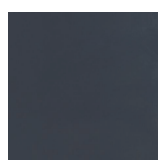

anthracite



noir